

**CAD FILES**  
AVAILABLE FOR SPECIFIERS



easyniche<sup>+</sup>  
TECHNICAL  
GUIDE 2017



# easyniche<sup>+</sup>

# TECHNICAL

# GUIDE 2017

---

## EASYNICHE

EasyNiche Tile-over accessory	2
Tile-over large rectangle	3
Tile-over small rectangle	4
Tile-over square	5
Tile-over Footrest	6
Exposed 12mm	7
Retrofit	8
Recessed Towel Warmer – Retrofit	9
Recessed Towel Warmer – Exposed/Tile-in	10

---

# EASYNICHE TILE-OVER ACCESSORY

## NEW EASYNICHE™ SIZES AVAILABLE TO FIT WITH YOUR CHOICE OF TILE

Start with your overall tile length to select the EasyNiche™ that will work best for your space.

Standard thickness tiles will fit the recess size indicated.

### LARGE RECTANGLE

OVERALL TILE LENGTH	RECESS SIZE (mm)	CODE
1500mm	1540 X 340	EN1500
1200mm	1240 X 340	EN1200
900mm	940 X 340	EN900
750mm	790 X 340	EN750

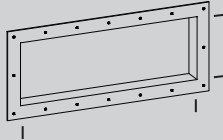

### SMALL RECTANGLE

OVERALL TILE LENGTH	RECESS SIZE (mm)	CODE
600mm	640 X 340	EN600
500mm	540 X 340	EN500
450mm	490 X 340	EN450
350mm	390 X 340	EN350
200mm	240 X 340	EN200

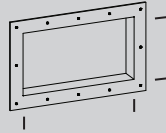

### SQUARE

OVERALL TILE LENGTH	RECESS SIZE (mm)	CODE
300mm	340 X 340	EN300

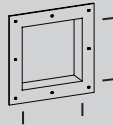

### FOOT REST

OVERALL TILE LENGTH	RECESS SIZE (mm)	CODE
140mm	180 X 120	EN140F



## SPECIFICATION

- One-piece lightweight construction made from rigid HIPS composite.
- 100% waterproof.
- Immediately ready-to-tile (once interlayer is applied).
- Built-in gradient prevents water ponding.
- Compliant with NZ Building Code and AS3740.
- Fits into 90mm wall cavity.
- 65mm waterproofing flange.
- Suitable for horizontal or vertical installation (except footrest).
- Suitable for all wallboards (recommended 6mm minimum).
- Supplied with self-adhesive connection sheet for waterproofing, primer and fixings.
- Must be installed prior to wallboard, and requires additional framing for correct setup.
- 25-year durability and leak-free warranty.

## INSTALLS EASILY INTO WALL FRAMING



Overview only. See installation instructions or video on our website for correct method.

# EASYNICHE TILE-OVER LARGE RECTANGLE

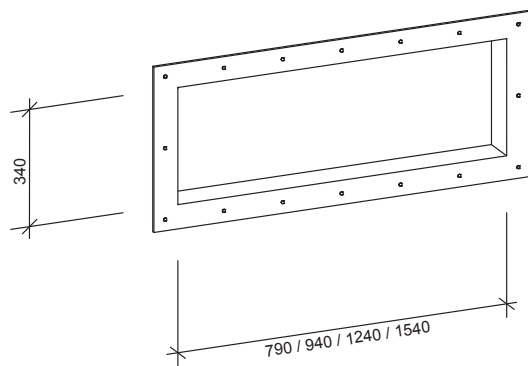

Perspective

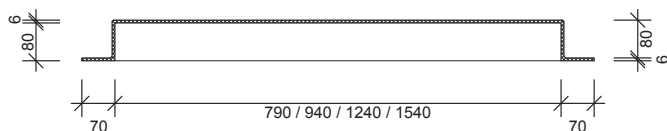

Section

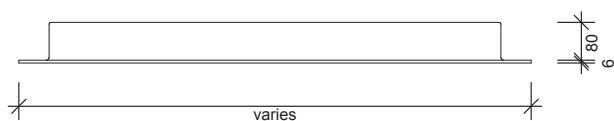

Plan

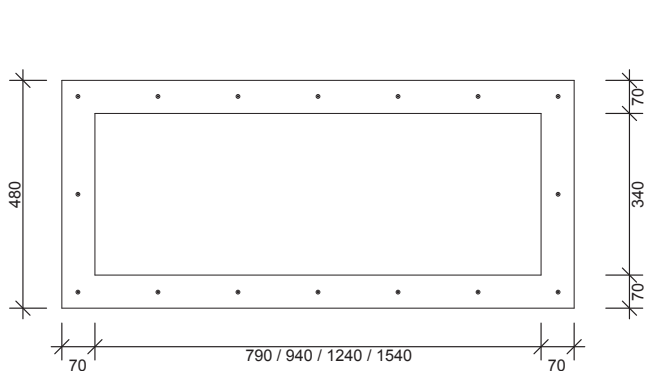

Front Elevation

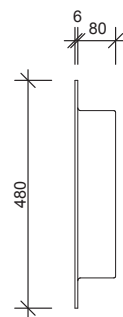

Side Elevation

# EASYNICHE TILE-OVER SMALL RECTANGLE

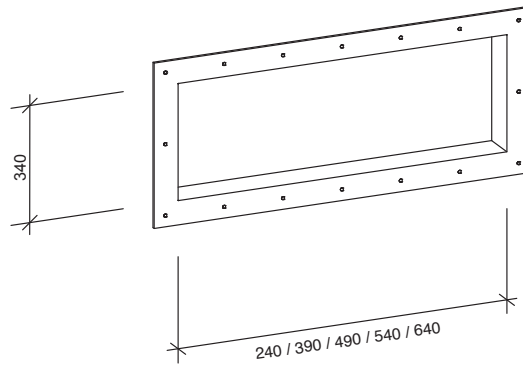

Perspective

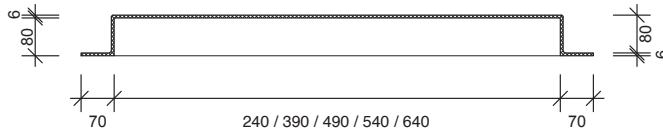

Section



Plan

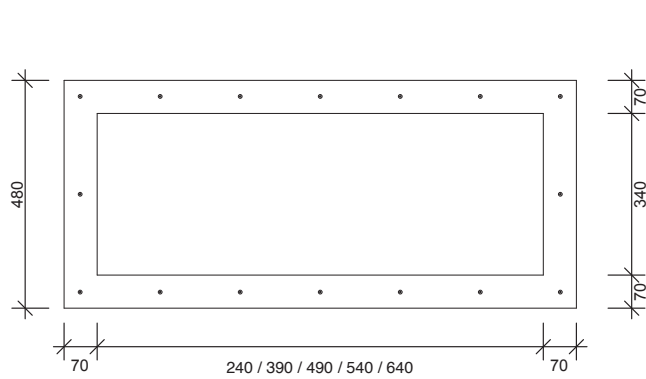

Front Elevation

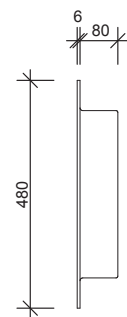

Side Elevation

# EASYNICHE TILE-OVER SQUARE

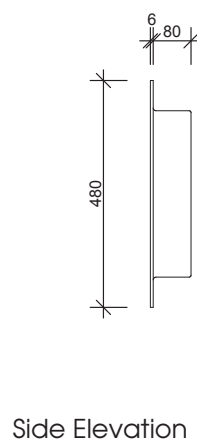
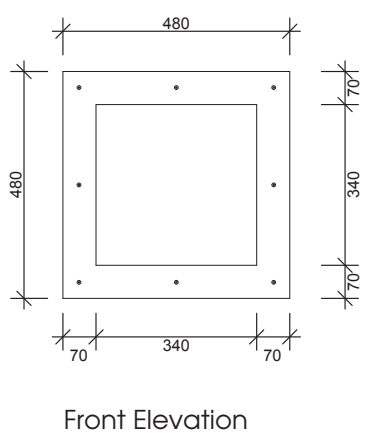
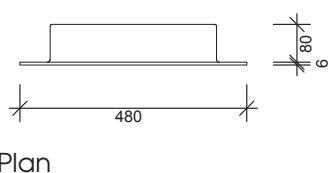
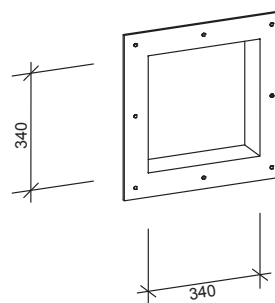
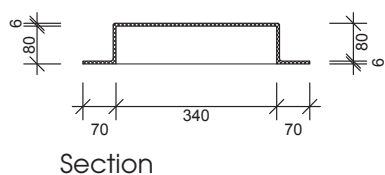

# EASYNICHE TILE-OVER FOOTREST

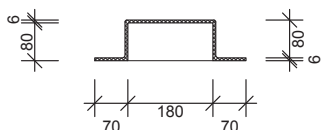

Section

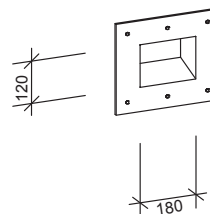

Perspective

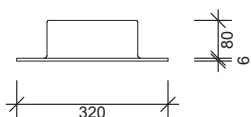

Plan

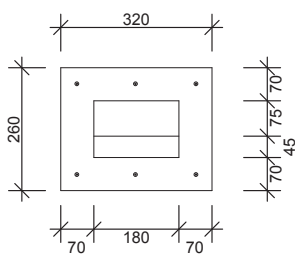

Front Elevation

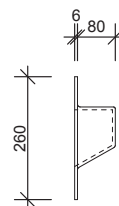

Side Elevation



# EASYNICHE EXPOSED 12mm

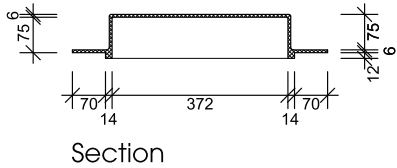

Section

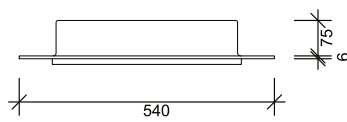

Plan

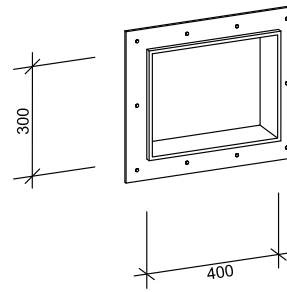

Perspective

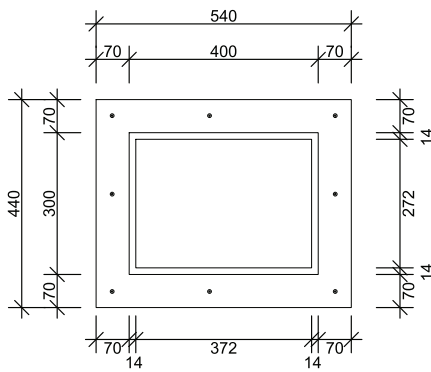

Front Elevation

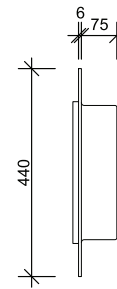

Side Elevation

## SPECIFICATION

- One-piece gloss white lightweight construction made from rigid PMMA composite.
- Available in one size 400mm x 300mm.
- 65mm waterproofing flange
- Must be installed prior to wallboard and requires additional framing.
- Supplied with installation materials.
- 7-year warranty.
- To suit 8mm to 12mm tiles.



## INSTALLATION STEPS:



Overview only. See installation instructions or video on our website for correct method.

# EASYNICHE RETROFIT

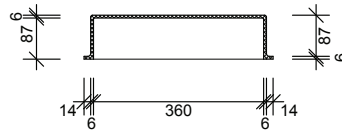

Section

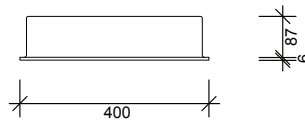

Plan

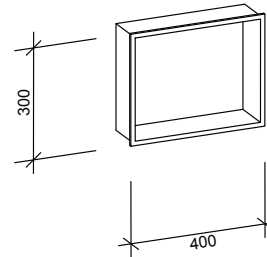

Perspective

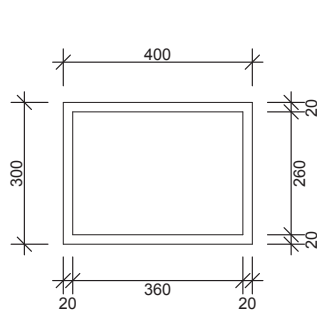

Front Elevation

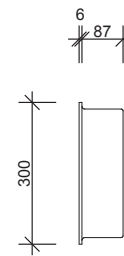

Side Elevation

## INSTALLATION STEPS:



Overview only. See installation instructions or video on our website for correct method.

## SPECIFICATION

- One-piece lightweight construction made from rigid gloss white PMMA.
- Available in one size 400mm x 300mm.
- Designed to be installed to new or existing acrylic liner or Ellure™ Walls.
- Protrudes 6mm from wall surface finish.
- Can be installed horizontally or vertically.
- Built in gradient prevents water ponding.
- Supplied with installation materials.
- 7-year warranty.

# EASYNICHE RECESSED TOWEL WARMER RETROFIT

For installation into prefinished (non-tiled) walls

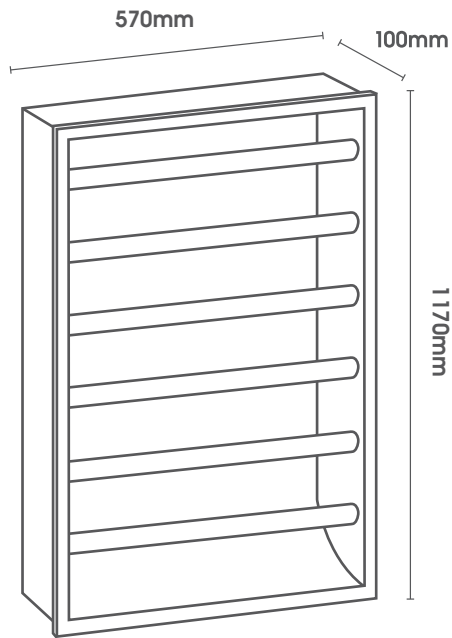

Perspective

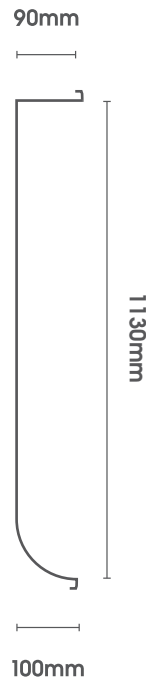

Side Elevation

## INSTALLATION STEPS:



Overview only. See installation instructions for correct method.

## SPECIFICATION

- Available in gloss white finish only.
- Available in one size 1200mm x 600mm.
- Fits into a 90mm wall cavity.
- Electrical components must be installed prior to wallboard.
- Must be retrofitted when wall is finished.
- Supplied with installation materials.

# EASYNICHE RECESSED TOWEL WARMER EXPOSED/TILE-IN

For installation into tiled walls (prior to tiling)

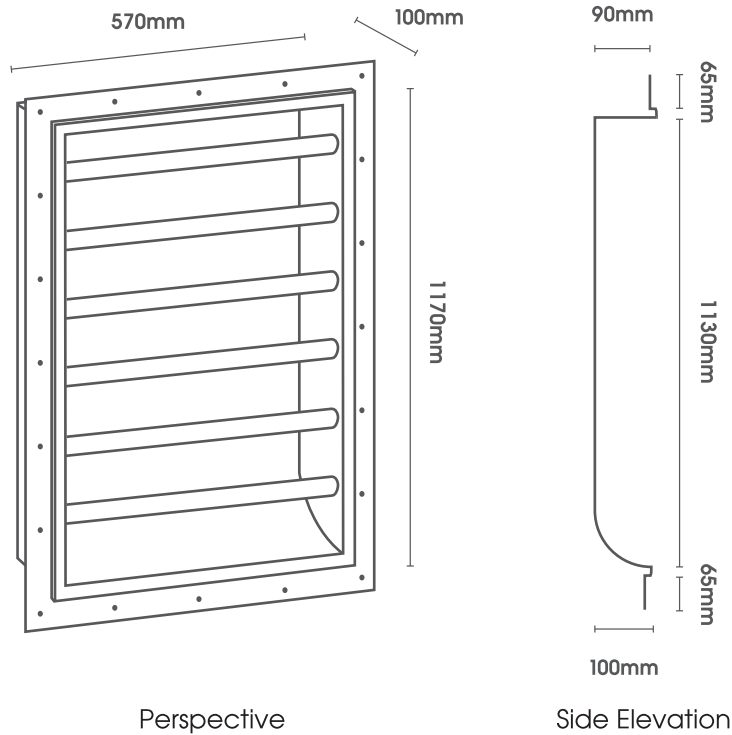

Perspective

Side Elevation

## INSTALLATION STEPS:



Overview only. See installation instructions for correct method.

## SPECIFICATION

- Available in gloss white finish only.
- Available in one size 1200mm x 600mm.
- Fits into a 90mm wall cavity.
- Features a 65mm waterproofing flange.
- To suit 8mm to 12mm tiles.
- Must be installed prior to wallboard and requires additional framing and electrical work.
- Supplied with installation materials.

Atlantis Bathroom Style | 0800 428 526 | [www.atlantis.net.nz](http://www.atlantis.net.nz)

© Copyright and all other intellectual property rights apply to this document and the products herein.